

Table of Contents (1)

Title	Page
Overview -----	3
Unpacking Inspection -----	4
Safety Information -----	5
Rules For Safe Operation -----	7
International Electrical Symbols -----	10
The Meter structure -----	11
Functional Buttons -----	12
Measurement Operation -----	13
A. DC Voltage Measurement -----	13
B. AC Voltage Measurement -----	15
C. DC Current Measurement -----	17
D. Measuring Resistance -----	20
E. Diodes and Continuity Measurement -----	22
F. Temperature Measurement -----	25
G. Battery Test -----	27

Table of Contents (2)

Title	Page
H. Square Wave Output -----	28
General Specifications -----	29
Accuracy Specifications -----	31
A. DC Voltage -----	31
B. AC Current -----	32
C. DC Current -----	33
D. Resistance -----	34
E. Diodes and Continuity Measurement -----	35
F. Temperature -----	35
G. Battery Test -----	36
H. Square Wave Output -----	36
Maintenance -----	37
A. General Service -----	37
B. Replacing the Battery -----	38
C. Replacing the Fuses -----	39

This Operating Manual covers information on safety and cautions. Please read the relevant information carefully and observe all the **Warnings** and **Notes** strictly.

 **Warning**

To avoid electric shock or personal injury, read the “Safety Information” and “Rules for Safety Operation” carefully before using the Meter.

The Model **UT33B**, **UT33C** and **UT33D** Multimeters (hereafter referred as “the Meter”) are 3 1/2 digits with steady operations, fashionable design and highly reliable hand-held measuring instrument. The Meter can measure AC/DC voltage, AC/DC Current, Resistance, Temperature, Diode and Continuity. It is an ideal tool for maintenance.

Except where noted, the descriptions and instructions in this Operating Manual apply to all **Model UT33B/UT33C/UT33D**.



Model UT33B/C/D: OPERATING MANUAL

Unpacking Inspection

Open the package case and take out the Meter. Check the following items carefully to see any missing or damaged part:

Item	Description	Qty
1	English Operating Manual	1 piece
2	Test Lead	1 pair
3	Point Contact Temperature Probe (UT33C only)	1 piece
4	Holster	1 piece

In the event you find any missing or damage, please contact your dealer immediately.

Safety Information

This Meter complies with the standards IEC61010: in pollution degree 2, overvoltage category (CAT I 600V, CAT II 300V) and double insulation.

CAT. I: Signal level, special equipment or parts of equipment, telecommunication, electronic, etc., with smaller transient overvoltages than overvoltages CAT. II.

CAT. II: Local level, appliance, PORTABLE EQUIPMENT etc., with smaller transient overvoltages than CAT. III

Use the Meter only as specified in this operating manual, otherwise the protection provided by the Meter may be impaired.



Model UT33B/C/D: OPERATING MANUAL

Safety Information(2)

In this manual, a **Warning** identifies conditions and actions that pose hazards to the user, or may damage the Meter or the equipment under test. A **Note** identifies the information that user should pay attention on.

International electrical symbols used on the Meter and in this Operating Manual are explained on page 10.

 **Warning**











To avoid possible electric shock or personal injury, and to avoid possible damage to the Meter or to the equipment under test, adhere to the following rules:

- 1 Before using the Meter inspect the case. Do not use the Meter if it is damaged or the case (or part of the case) is removed. Look for cracks or missing plastic. Pay attention to the insulation around the connectors.
- 1 Inspect the test leads for damaged insulation or exposed metal. Check the test leads for continuity. Replace damaged test leads with identical model number or electrical specifications before using the Meter.
- 1 Do not apply more than the rated voltage, as marked on the Meter, between the terminals or between any terminal and grounding.
- 1 The rotary switch should be placed in the right position and no any changeover of range shall be made during measurement is conducted to

prevent damage of the Meter.

- 1 When the Meter working at an effective voltage over 60V in DC or 42V rms in AC, special care should be taken for there is danger of electric shock.
- 1 Use the proper terminals, function, and range for your measurements.
- 1 Do not use or store the Meter in an environment of high temperature, humidity, explosive, inflammable and strong magnetic field. The performance of the Meter may deteriorate after dampened.
- 1 When using the test leads, keep your fingers behind the finger guards.
- 1 Disconnect circuit power and discharge all high-voltage capacitors before testing resistance, continuity, diodes and current.
- 1 Before measuring current, check the Meter's fuses and turn off power to the circuit before connecting the Meter to the circuit.
- 1 Replace the battery as soon as the battery indicator  appears. With a low battery, the Meter might produce false readings that can lead to electric shock and personal injury.

- 1 **Remove test leads and temperature probe from the Meter and turn the Meter power off before opening the Meter case.**
- 1 **When servicing the Meter, use only the same model number or identical electrical specifications replacement parts.**
- 1 **The internal circuit of the Meter shall not be altered at will to avoid damage of the Meter and any accident.**
- 1 **Soft cloth and mild detergent should be used to clean the surface of the Meter when servicing. No abrasive and solvent should be used to prevent the surface of the Meter from corrosion, damage and accident.**
- 1 **The Meter is suitable for indoor use.**
- 1 **Turn the Meter off when it is not in use and take out the battery when not using for a long time.**
- 1 **Constantly check the battery as it may leak when it has been using for some time, replace the battery as soon as leaking appears. A leaking battery will damage the Meter,**

	AC or DC
	AC Current
	DC Current
	Earth Ground
	Double Insulated.
	Low Battery.
	Diode.
	Fuse.
	Continuity Test
	Safety Rules
	Conforms to Standards of European Union.

The Meter Structure (figure 1)

- 1) LCD Display
- 2) HOLD Button
- 3) Display Backlight Button
- 4) Rotary Switch
- 5) COM Input Terminal
- 6) 10A Input Terminal
- 7) Other Input Terminals

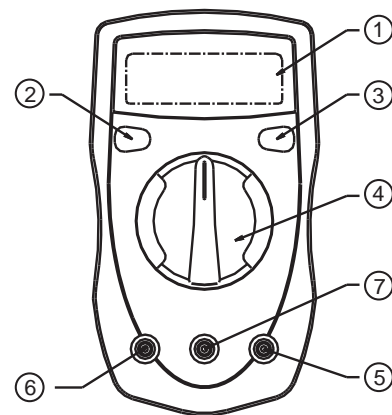

(figure 1)

Functional Buttons

Below table indicated for information about the functional button operations.

Button	Operation Performed
HOLD button	1 Press HOLD once to enter hold mode.
	1 Press HOLD again to exit hold mode.
	1 In Hold mode,  is displayed and the present value is shown.
BLUE button	1 Press BLUE button once to turn the display backlight on.
	1 Press BLUE button again to turn the display backlight off.
	1 Display backlight will NOT be automatically off unless pressing the BLUE button

A. DC Voltage Measurement (see figure 2)

Warning

To avoid harms to you or damages to the Meter from electric shock, please do not attempt to measure voltages higher than 500V although readings may be obtained.

The DC Voltage ranges are: 200mV, 2000mV, 20V, 200V and 500V. To measure DC voltage, connect the Meter as follows:

1. Insert the red test lead into the **VΩmA** terminal and the black test lead into the **COM** terminal.
2. Set the rotary switch to an appropriate measurement position in **V $\overline{\text{---}}$** range.
3. Connect the test leads across with the object being measured.

The measured value shows on the display.

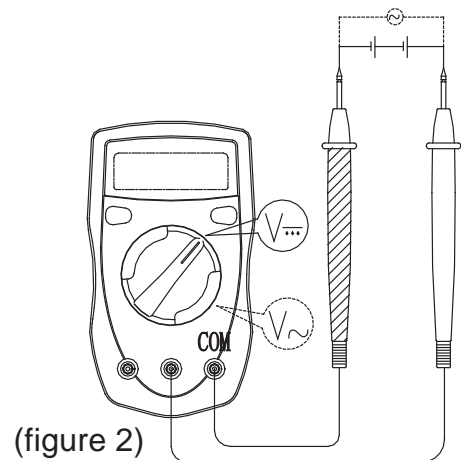

Note

- 1 If the value of voltage to be measured is unknown, use the maximum measurement position (500V) and reduce the range step by step until a satisfactory reading is obtained.
- 1 The LCD displays “1” indicating the existing selected range is overload; it is required to select a higher range in order to obtain a correct reading.
- 1 In each range, the Meter has an input impedance of approx. $10M\Omega$. This loading effect can cause measurement errors in high impedance circuits. If the circuit impedance is less than or equal to $10k\Omega$, the error is negligible (0.1% or less).
- 1 When DC voltage measurement has been completed, disconnect the connection between the testing leads and the circuit under test.

B. AC Voltage Measurement (see figure 2)

Warning

To avoid harms to you or damages to the Meter from electric shock, please do not attempt to measure voltages higher than 500Vrms although readings may be obtained.

The AC voltage measurement positions are: 200V and 500V. To measure AC Voltage, connect the Meter as follows:

1. Insert the red test lead into the **VΩmA** terminal and the black test lead into the **COM** terminal.
2. Set the rotary switch to an appropriate measurement position in **V~** range.
3. Connect the test leads across with the object being measured.

The measured value shows on the display, which is effective value of sine wave (mean value response).

Note

- 1 If the value of voltage to be measured is unknown, use the maximum measurement position (500V) and reduce the range step by step until a satisfactory reading is obtained.
- 1 The LCD displays “1” indicating the existing selected range is overload, it is required to select a higher range in order to obtain a correct reading.
- 1 In each range, the Meter has an input impedance of approx. $10M\Omega$. This loading effect can cause measurement errors in high impedance circuits. If the circuit impedance is less than or equal to $10k\Omega$, the error is negligible (0.1% or less).
- 1 When AC voltage measurement has been completed, disconnect the connection between the testing leads and the circuit under test.

C. DC Current Measurement (see figure 3)

Warning

Never attempt an in-circuit current measurement where the voltage between terminals and ground is greater than 60V. If the fuse burns out during measurement, the Meter may be damaged or the operator himself may be hurt. Use proper terminals, function, and range for the measurement. When the testing leads are connected to the current terminals, do not parallel them across any circuit.

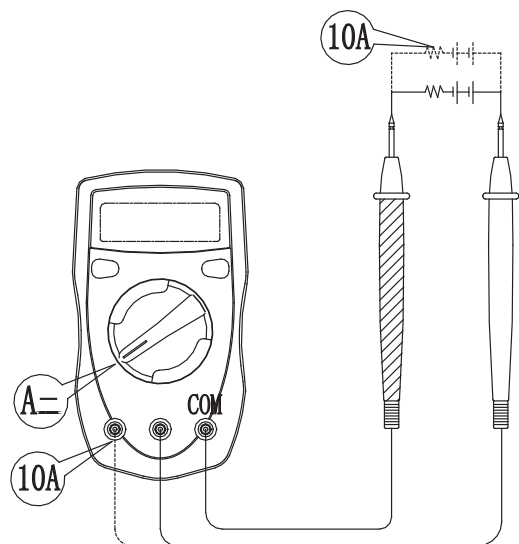

(figure 3)

The Model UT33B: the current measurement has 3 measurement positions on the rotary switch: 200 μ A, 200mA and 10A.

The Model UT33C/UT33D: the current measurement has 4 measurement positions on the rotary switch: 2000 μ A, 20mA, 200mA and 10A

To measure current, do the following:

1. Turn off power to the circuit. Discharge all high-voltage capacitors.
2. Insert the red test lead into the **V Ω mA** or 10A terminal and the black test lead into the **COM** terminal.
3. Set the rotary switch to an appropriate measurement position in **A $\overline{\text{---}}$** range.
4. Break the current path to be tested. Connect the red test lead to the more positive side of the break and the black test lead to the more negative side of the break.
5. Turn on power to the circuit.

The measured value shows on the display.

Note

- 1 If the value of current to be measured is unknown, use the maximum measurement position (10A)
- 1 and reduce the range step by step until a satisfactory reading is obtained.
- 1 When current measurement has been completed, disconnect the connection between the testing leads
- 1 and the circuit under test.

D. Measuring Resistance (see figure 4)

Warning

To avoid damages to the Meter or to the devices under test, disconnect circuit power and discharge all the high-voltage capacitors before measuring resistance.

The Model UT33B/UT33C: The resistance measurement positions are: 200Ω , 2000Ω , $20k\Omega$, $200k\Omega$ and $20M\Omega$

The Model UT33D: The resistance measurement positions are: 200Ω , 2000Ω , $20k\Omega$, $200k\Omega$, $20M\Omega$ and $200M\Omega$

To measure resistance, connect the Meter as follows:

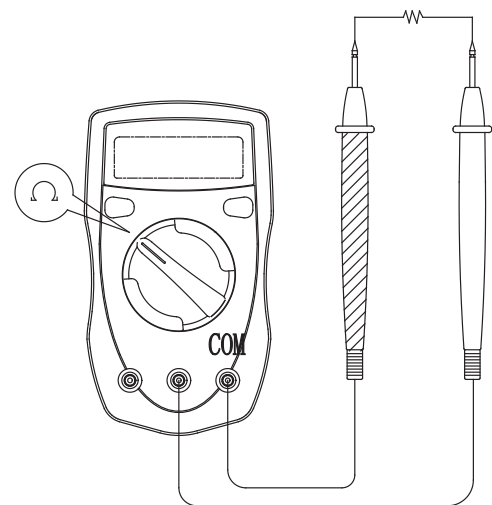

(figure 4)

1. Insert the red test lead into the V Ω mA terminal and the black test lead into the COM terminal.
2. Set the rotary switch to an appropriate measurement position in Ω range.
3. Connect the test leads across with the object being measured.

The measured value shows on the display.

Note

- 1 The test leads can add 0.1 Ω to 0.3 Ω of error to resistance measurement. To obtain precision readings in low-resistance measurement, that is the range of 200 Ω , short-circuit the input terminals beforehand and record the reading obtained (called this reading as X). (X) is the additional resistance from the test lead. Then use the equation:
measured resistance value (Y) – (X) = precision readings of resistance.
- 1 For high-resistance measurement (>1M Ω), it is normal taking several seconds to obtain a stable reading.
- 1 When resistance measurement has been completed, disconnect the connection

between the testing leads and the circuit under test.

E. Diodes and Continuity Measurement (see figure 5)

Testing Diodes

Warning

To avoid amages to the Meter or to the devices under test, disconnect circuit power and discharge all the high-voltage capacitors before diodes.

Use the diode test to check diodes, transistors, and other semiconductor devices. The diode test sends a current through the semiconductor junction, and then measures the voltage drop

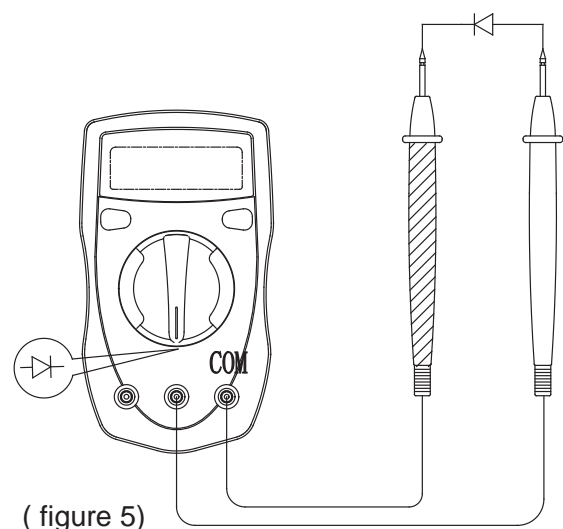

across the junction. A good silicon junction drops between 0.5V and 0.8V.

To test a diode out of a circuit, connect the Meter as follows:

1. Insert the red test lead into the **VΩmA** terminal and the black test lead into the COM terminal.
2. Set the rotary switch to **→|** (The Model: **UT33B**) or **→|•|** (The Model: **UT33C/UT33D**)
3. For forward voltage drop readings on any semiconductor component, place the red test lead on the component's anode and place the black test lead on the component's cathode.

The measured value shows on the display.

Note

- 1 In a circuit, a good diode should still produce a forward voltage drop reading of 0.5V to 0.8V; however, the reverse voltage drop reading can vary depending on the resistance of other pathways between the probe tips.

- 1 Connect the test leads to the proper terminals as said above to avoid error display. The LCD will display “1” indicating open-circuit for wrong connection. The unit of diode is Volt (V), displaying the positive-connection voltage-drop value.
- 1 When diode testing has been completed, disconnect the connection between the testing leads and the circuit under test.

The Model UT33C/UT33D: Testing for Continuity

To test for continuity, connect the Meter as below:

1. Insert the red test lead into the VΩmA terminal and the black test lead into the COM terminal.
2. Set the rotary switch to .
3. Connect the test leads across with the object being measured.

The buzzer sounds if the resistance of a circuit under test is less than 70Ω.

Note

- 1 The LCD displays “1” indicating the circuit being tested is open.

- I When continuity testing has been completed, disconnect the connection between the testing leads and the circuit under test.

F. Model UT33C: Temperature Measurement (see figure 6)

⚠ Warning

To avoid harms to you or damages to the Meter, please do not attempt to input voltages higher than 60V in DC or 30V in AC.

The Temperature measurement range is $-40^{\circ}\text{C} \sim 1000^{\circ}\text{C}$ or $-40^{\circ}\text{F} \sim 1832^{\circ}\text{F}$. To measure temperature, connect the Meter as follows:

1. Insert the red temperature probe into the **V Ω mA** terminal and the black temperature probe into the COM temperature.

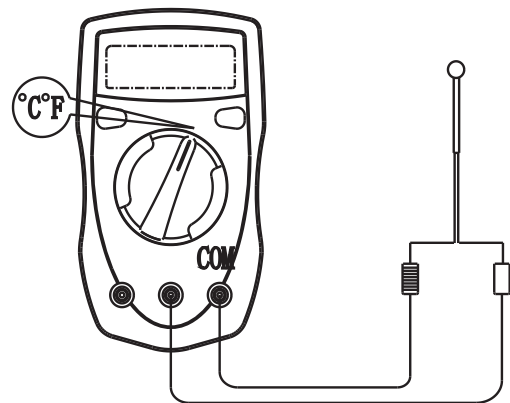

(figure 6)

2. Set the rotary switch to °C or °F.
3. Place the temperature probe to the object being measured.
The measured value shows on the display.

Note

- 1 The Meter automatically displays the temperature value inside the Meter when there is no temperature probe connection.
- 1 The included point contact temperature probe can only be used up to 250°C(482°F). For any measurement higher than that, the rod type temperature probe must be used instead.
- 1 When temperature measurement has been completed, disconnect the connection between the testing leads and the circuit under test.

G. The Model UT33B: Battery Test (see figure 7)

⚠ Warning

To avoid harms to you or damages to the Meter, please do not attempt to input voltages higher than 60V in DC or 30V in AC.

To test the battery, proceed as follows:

1. Insert the red test into the $V\Omega mA$ terminal and the black test leads into the COM terminal.
2. Set the rotary switch to an appropriate measurement position in —|— range.
3. Connect the test leads across with the battery being measured ensuring the polarity is correct.

The measured value shows on the display, which is the voltage between the cathode and anode of the battery.

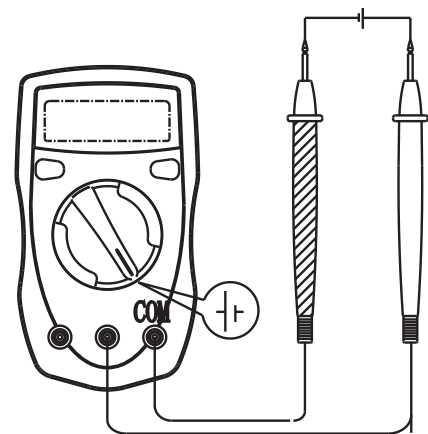

(figure 7)

Note

- 1 When battery testing has been completed, disconnect the connection between the testing leads and the circuit under test.

H. The Model UT33D: Square Wave Output

Warning

To avoid damages to the Meter, do not allow output terminals (red test lead) to reach higher than 10V.

To measure square wave output proceed as follows:

1. Set the rotary switch to \square OUT.
2. The square wave signal outputs between **V Ω mA** and COM Terminals.

Note



- 1 The frequency is approx. 50Hz.
- 1 The output scope higher than 3Vpp when it is loaded 1M Ω .

- 1 When square wave output testing has been completed, disconnect the connection between the testing leads and the circuit under test.

General Specifications

- 1 Maximum Voltage (including transient overvoltage) between any Terminals and Grounding: 500V rms.
- 1 Δ Fused Protection for V Ω mA Input Terminal: 315mA, 250V fast type, ϕ 5x20 mm
- 1 10A Terminal: Un-fused.
- 1 Range: Manual ranging
- 1 Maximum Display: Display: 1999.
- 1 Measurement Speed: Updates 2~3 times /second.
- 1 Temperature:
 - Operating: 0°C~40°C (32°F~104 °F).
 - Storage: -10°C~50°C (14°F~122°F).
- 1 Relative Humidity: \leq 75% @ 0°C - 30°C; \leq 50% @ 31 - 40°C.

General Specifications(2)

- 1 Altitude:Operating: 2000 m.
Storage: 10000 m.
- 1 Battery Type: One piece of 9V Battery NEDA 1604 or 6F22 or 006P.
- 1 Battery Deficiency: Display:  .
- 1 Negative reading: Display:  .
- 1 Overloading: Display: **1**.
- 1 Dimensions (HxWxL): 130 x 73.5 x 35mm.
- 1 Weight: Approx. 156g (battery included).
- 1 Safety/Compliances: IEC61010 CAT.I 600V overvoltage and double insulation standard.
- 1 Certification: 

Model UT33B/C/D: OPERATING MANUAL
Accuracy Specifications(1)



Accuracy: $\pm(a\% \text{ reading} + b \text{ digits})$, guarantee for 1 year.
 Operating temperature: $23^{\circ}\text{C} \pm 5^{\circ}\text{C}$.
 Relative humidity: $<75\%$.
 Temperature coefficient: $0.1 \times (\text{specified accuracy}) / 1^{\circ}\text{C}$.

A. DC Voltage

Range	Resolution	Accuracy			Overload Protection
		UT33B	UT33C	UT33D	
200mV	100 μ V	$\pm(0.5\%+2)$			250V DC or AC
2000mV	1mV				
20V	10mV				
200V	100mV	$\pm(0.8\%+2)$			500V DC or AC
500V	1V				

Remark: Input impedance: 10M Ω .

B. AC Voltage

Range	Resolution	Accuracy			Overload Protection
		UT33B	UT33C	UT33D	
200V	100mV	± (1.2%+10)			500V DC or AC
500V	1V				

Remarks:

- 1 Input impedance: approx. 5MΩ.
- 1 Displays effective value of sine wave (mean value response).
- 1 Frequency response 40Hz ~ 400Hz.

C. DC Current

Range	Resolution	Accuracy			Overload Protection
		UT33B	UT33C	UT33D	
200μA	0.1μA	±(1%+2)	-----		315mA, 250V fast type fuse: φ 5x20mm
2000μA	1μA	-----	±(1%+2)		
20mA	10μA				
200mA	100μA	±(1.2%+2)			Un-Fused
10A	10mA	±(2%+5)			



Remark:

- 1 **At 10A Range:** For continuous measurement ≤10 seconds and interval not less than 15 minutes.

D. Resistance

Range	Resolution	Accuracy			Overload Protection
		UT33B	UT33C	UT33D	
200Ω	0.1Ω	±(0.8%+5)			250V DC or AC
2000Ω	1Ω	±(0.8%+2)			
20kΩ	10Ω				
200kΩ	100Ω				
20MΩ	10kΩ	±(1%+5)			
200MΩ	100kΩ	-----	± [5%(reading-10)+10]		

E. Diodes and Continuity Measurement (Continuity test only for UT33C/UT33D)

Range	Resolution	Remark	Overload Protection
	1mV	Displays approximate forward voltage drop: 0.5V~0.8V.	250V DC or AC
	1Ω	Buzzer beeps at <70Ω	

F. The Model UT33C: Temperature

Range	Resolution	Remark	Overload Protection
-40°C~150°C	1°C	± (1%+3)	250V DC or AC
150°C~1000°C		± (1.5%+15)	
-40°F~302°F	1°F	± (1%+4)	
302°F~1832°F		± (1.5%+15)	

G. The Model UT33B: Battery Test

Range	Resolution	Internal Resistance
12V	10mV	240Ω
9V	10mV	1.8kΩ
1.5V	10mV	30Ω

H. The Model UT33D: Square Wave Output

Range	Illustration
□ OUT	Approx. output 50Hz square wave signal. As a simple signal source with 47kΩ resistance output.

Remark:

- 1 No overload protection.
- 1 Make sure voltage output of calibrated equipment level is less than 10V to avoid damages to the meter.

This section provides basic maintenance information including battery and fuse replacement instruction.

 **Warning**

Do not attempt to repair or service your Meter unless you are qualified to do so and have the relevant calibration, performance test, and service information. To avoid electrical shock or damage to the Meter, do not get water inside the case.

A. General Service

- 1 Periodically wipe the case with a damp cloth and mild detergent. Do not use abrasives or solvents.
- 1 To clean the terminals with cotton bar with detergent, as dirt or moisture in the terminals can affect readings.
- 1 Turn the Meter to OFF position when it is not in use and take out the battery when not using for a long time.

- 1 Do not store the Meter in a place of humidity, high temperature, explosive, inflammable and strong magnetic field.

B. Replacing the Battery (see figure 8)

Warning

To avoid false readings, which could lead to possible electric shock or personal injury, replace the battery as soon as the battery indicator “” appears.

To replace the battery:

1. Disconnect the connection between the testing leads and the circuit under test, and remove the testing leads away from the input terminals of the Meter.

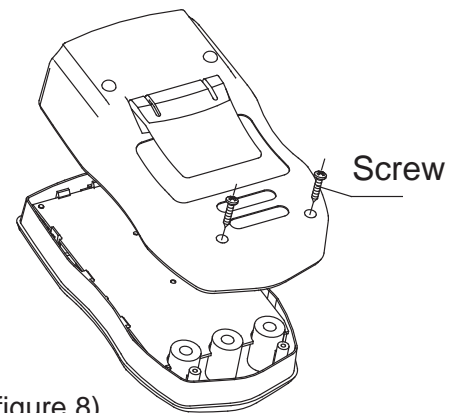

2. Turn the Meter to OFF position.
3. Remove the screw from case bottom, and separate the case bottom from the case top.
4. Remove the battery from the battery compartment.
5. Replace the battery with a new 9V battery (NEDA 1604 or 6F22 or 006P).
6. Rejoin the case bottom and case top, and reinstall the screw.

C. Replacing the Fuses (See figure 8)

Warning

To avoid electrical shock or arc blast, or personal injury or damage to the Meter, use specified fuses ONLY in accordance with the following procedure.

To replace the Meter's fuse:

1. Disconnect the connection between the testing leads and the circuit under test, and remove the testing leads away from the input terminals of the Meter.
2. Turn the Meter to OFF position.

3. Remove the screw from case bottom, and separate the case bottom from the case top.
4. Remove the fuse by gently prying one end loose, and then take out the fuse from its bracket.
5. Install **ONLY** replacement fuses with the identical type and specification as follows and make sure the fuse is fixed firmly in the bracket. 315mA, 250V, fast type, ϕ 5x20mm.
6. Rejoin the case bottom and case top, and reinstall the screw.

Replacement of the fuses is seldom required. Burning of a fuse always results from improper operation.

**** END ****

Model UT33B/C/D: OPERATING MANUAL

UNI-T®



Model UT33B/C/D: OPERATING MANUAL

©Copyright 2002 Uni-Trend Group Limited.
All rights reserved.

Manufacturer:
Uni-Trend Technology (Dongguan) Limited
Dong Fang Da Dao
Bei Shan Dong Fang Industrial Development District
Hu Men Town, Dongguan City
Guang Dong Province
China
Postal Code: 523 925

Headquarters:
Uni-Trend Group Limited
Rm901, 9/F, Nanyang Plaza
57 Hung To Road
Kwun Tong
Kowloon, Hong Kong
Tel: (852) 2950 9168
Fax: (852) 2950 9303
Email: info@uni-trend.com
<http://www.uni-trend.com>